

Vickers®

Solenoid Operated Directional Valves
Explosion Proof ATEX, UL, CSA

DG4V-3S, X4 & X5
DG4V4-01, X5

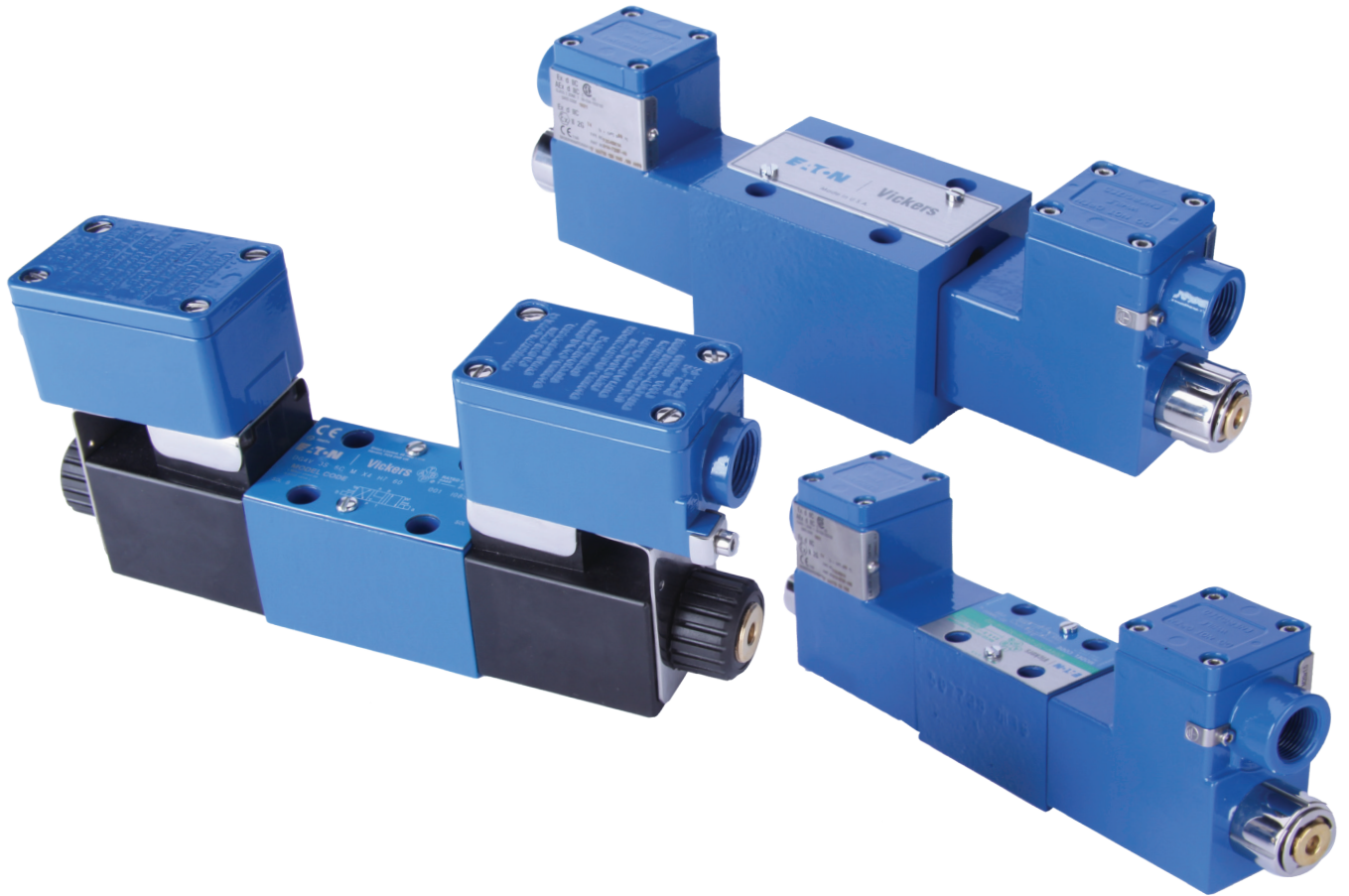

EATON

Powering Business Worldwide

Table of Contents

Introduction

General Description	3
Features and Benefits	3
Characteristics	3
Typical Side View	3

Model Code	4
-------------------------	---

Spool Data	5
-------------------------	---

Functional Symbol	5
--------------------------------	---

Operating Data	6
-----------------------------	---

Performance Data	7
-------------------------------	---

Installation Dimensions	9
--------------------------------------	---

Application Data	10
-------------------------------	----

Introduction

General Description

These solenoid operated directional control valves are for directing and stopping flow at any point in a hydraulic system. This series has been specially designed and developed for equipment that has been installed in new applications in potentially explosive atmospheres.

DG4V-3S, X4 option

- ATEX approval
- Hazardous locations - Ex II 2 G; Zone 1 and Zone 2.
- Protection type - EEx me II T4; "increased safety" and "encapsulated"

DG4V-3S and DG4V4, X5 option

- ATEX, UL, and CSA approval; complies to all 3 directives
- ATEX approval; hazardous locations - Ex II 2 G; Zone 1

and Zone 2; protection type EEx d IIB T*," flameproof"

- UL and CSA approval; hazardous locations - Class 1, Group C/D; Class 2, Group E/F/G; Division 1 & 2

Characteristics

DG4V-3S-X4 & X5-6* Design Mounting interface

ISO 4401 size 03
ANSI/B93.7M size D03
CETOP RP65H, size 3
DIN 24340, NG6

Basic characteristics

Maximum pressure:
350 bar (5075 psi)
Maximum flow:
Up to 40 l/min (10.5 USgpm)

DG4V4-01, X5-10 Design Mounting interface

ISO 4401 size 05
ANSI/B93.7M size D05
CETOP RP65H, size 5
DIN 24340, NG10

Basic characteristics

Maximum pressure
315 bar (4500 psi)
Maximum flow up to 80 L/min
(21USgpm)

Features and Benefits

New expanded product offering for hazardous environments, opening up new opportunities.

- Multi-fluid capability without need to change seals.
- Higher sustained machine productivity and higher up] time because of proven fatigue life and endurance, tested over 10 million cycles.

Temperature limits

Minimum ambient:
-20°C (-4°F)
Maximum ambient:
+70°C (158°F)

Fluid temperature ▲

For mineral oil
Minimum = -20°C (-4°F)
Maximum = +70°C (158°F)

▲ The temperature limits of these valves are subject to specific operating conditions. Please refer to the Instruction for Use document supplied with each valve.

Model Code

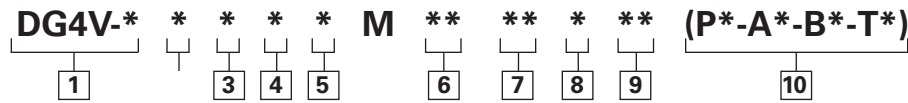

1 **Directional Control Valve**
DG4V-3S-D03/NG6
DG4V4-01-D05/NG10
 Subplate Mounted, Solenoid
 Operated, ISO 4401size

2 **Spool type**
0, 2, 6, 8*

* Other spools are available on request

3 **Spool/Spring
 Arrangement**

A – Spring offset, end to end
AL – As A but left hand build
B – Spring offset, end to
 center
BL – As B but left hand build
C – Spring centered

4 **Manual Override Options**
Blank – Plain overrides in sole-
 noid end only

5 **Solenoid Energisation
 Identity**

Blank – ANSI B93 9 (Sol. ‘a’
 flow from ‘P’ to ‘A’)

V – Solenoid ‘a’ at port ‘A’ end
 of valve and/or solenoid ‘b’ at
 ‘B’ end of valve

Note: 8 type spool must be ordered with V
 in model code

6 **Coil Type**

X4 (only available on DG4V-3S)

- ATEX approval; “Increased
 safety” and “encapsulated”
 solenoids to IEC classifica-
 tion EEx me II T4

X5

- ATEX, ExdIIc2G, approval;
 Zone 1 and 2, protection
 type “flame proof.”
- UL and CSA approval;
 Class 1, group C/D,
 Class 2 group, group E/F/G/
 Division 1 & 2

7 **Coil rating**
X5 Coil Availability

A – 110V AC, 50HZ

ER – 120V AC, 60HZ

C – 220V AC, 50HZ

ES – 240V AC, 60HZ
 (only for DG4V4-01)

H – 24V DC

OJ – 48V DC

P – 110V DC

X4 Coil Availability

H – 24V DC

G – 12V DC

8 **Tank Port Rating**

4 – 70 bar, for X5 valves only

7 – 210 bar, for X4 valves only

9 **Design Number**

60 – DG4V-3S

61 – 8C spool only,
 DG4V-3S

10 – DG4V4-01

10 **Port orifice plugs**

Blank – No orifice

P** – P port ** orifice size in
 1/10 mm (03 = 0.3)

A** – A port ** orifice size in
 1/10 mm (03 = 0.3)

B** – B port ** orifice size in
 1/10 mm (03 = 0.3)

T** – T port ** orifice size in
 1/10 mm (03 = 0.3)

Functional Symbols Spools

Available spool options

(illustrated to the right)
Configurations include
3-position and 2-position,
spring centered, spring off-
set and no-spring detented.

The valve function schematics apply to both U.S. and European valves.

DG4V-3-*N(V)

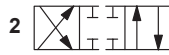

DG4V-3-*A(V)



DG4V-3-*AL(V)



DG4V-3-*C(V)

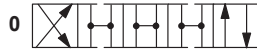

DG4V-3-*B/F(V)



DG4V-3-*BL/FL(V)

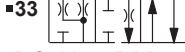
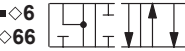
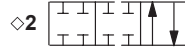
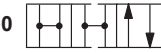

DG4V-3-8C(V)

DG4V-3-8BL(V)

DG4V-3-8B(V)

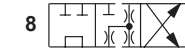
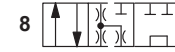
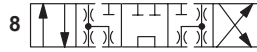

Solenoids identified to U.S. standards

(specify "A" in model code)

Functional symbols related to solenoid identity "A" and/or "B" according to NFPA/ANSI standards, i.e. energizing solenoid "A" gives flow P to A, solenoid "B" gives flow P to B (as applicable).

Location of solenoid "A" or "B" shown relative to the hydraulic work port.

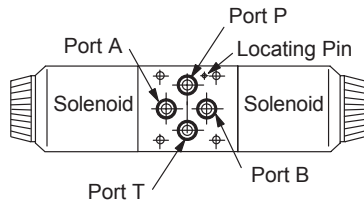

Solenoid	For Use with Spool Type	Solenoid
B	All except "8"	A
A	"8" only	B

"A" and "B" designations are printed on the name label adjacent to the solenoid indicator lights, illustrated above.

Double solenoid valves, two position, detented

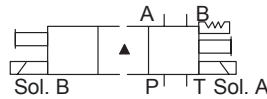

Double solenoid valves, spring centered

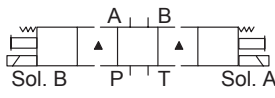

▲ Transient condition only

Single solenoid valves, solenoid at port A end

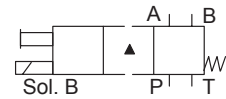

Single solenoid valves, solenoid at port B end

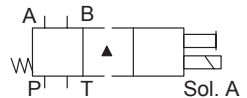

Solenoids identified to European standards

(specify "V" in model code)

Functional symbols related to solenoid identity "A" and/or "B" according to European convention i.e. solenoid "A" adjacent to "A" port, solenoid "B" adjacent to "B" port of valve.

Location of solenoid "A" or "B" shown relative the hydraulic work port.

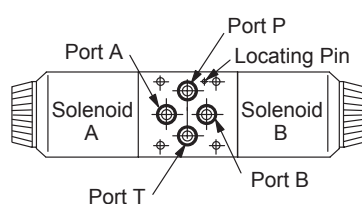

Solenoid	For Use with Spool Type	Solenoid
B	All spools	A

"A" and "B" designations are printed on the name label adjacent to the solenoid indicator lights, illustrated below.

Double solenoid valves, two position, detented

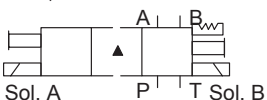

Double solenoid valves, spring centered

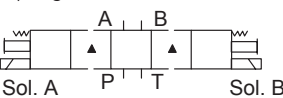

▲ Transient condition only

Single solenoid valves, solenoid at port A end

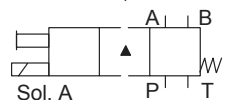

Single solenoid valves, solenoid at port B end

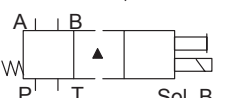

Operating Data

Data is typical, with fluid at 36 cST (168 SUS) and 50°C (122°F)

Valve size	DG4V-3S	DG4V4-01		
Pressure limits:				
P, A and B ports	350 bar		315 bar	
T port	70 bar for X5, 210 bar for X4		70 bar	
Flow rating	See performance data		See performance data	
Relative duty factor	Continuous rating (ED = 100%)		Continuous rating (ED = 100%)	
Type of protection	IEC 144 class IP66		IEC 144 class IP66	
Permissible Voltage Fluctuation	DC ± 10%		DC ± 10%	
Typical response times at 100% rated volts measured from application/removal of voltage to full spool displacement of "2C" spool at:			DC	AC
Flow Rate at P-A, B-T	20 l/min	20 l/min	40l/min	40l/min
Pressure, P Port	175 bar	175 ms	175 ms	175 ms
Energizing	60 ms	100 ms	60 ms	100 ms
De-energizing	40 ms	100 ms	40 ms	100 ms
Power consumption, solenoids at rated voltage and 20°C (68°F)				
X4 coils				
12V DC solenoid rating - type G	30W		30W	
24V DC solenoid rating - type H	30W		30W	
X5 coils				
24V DC solenoid rating - type H	17W		17W	
48V DC solenoid rating - type OJ	17W		17W	
110V DC solenoid rating - type P	17W		17W	
110V AC, 50Hz, solenoid rating - type A	20W		20W	
120V AC, 60Hz, solenoid rating - type ER	20W		20W	
220V AC, 50Hz, solenoid rating - type C	20W		20W	
240V AC, 60Hz, solenoid rating - type ES	20W		20W	

Performance Data

DG4V-3S, X4 and X5

Maximum flow rates

Typical with mineral oil at 36 cSt (168.6 SUS) and a specific gravity of 0.87. Performance based on full power solenoid coils warm and operating at 90% rated voltage.

Spool/Spring Code	DG4V-3S
0A(L)	2
0B(L) & 0C, 0F	1
2A(L)	2
2B(L) & 2C	2
6B(L) & 6C, 6F	3
8B(L) & 8C	4

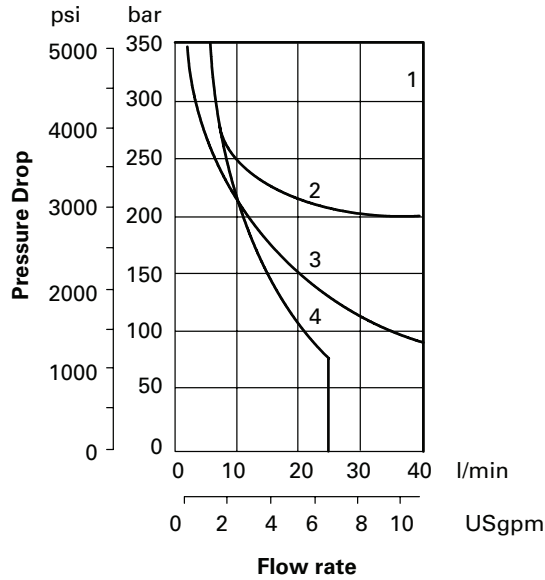

DG4V4-01, X5

Maximum flow rates

Typical with mineral oil at 36 cSt (168.6 SUS) and a specific gravity of 0.87. Performance based on full power solenoid coils warm and operating at 90% rated voltage.

Spool/Spring Code	DG4V4-01	
	AC	DC
0A(L)	1	4
0B(L) & 0C, 0F	1	4
2A(L)	1	4
2B(L) & 2C	1	4
6B(L) & 6C, 6F	2	4
8B(L) & 8C	3	4

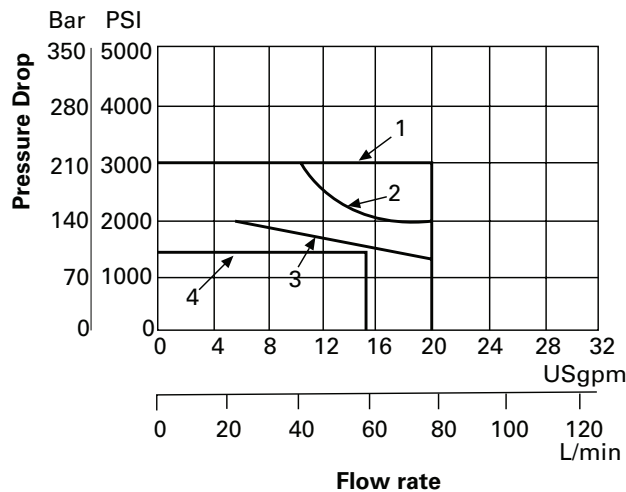

Performance Data

Flow Curves

DG4V-3S, X4 & X5

Spool/Spring Code	Spool Positions	P to A	P to B	A to T	B to T	P to T	B to A
0A(L)C	Both	5	5	2	2	-	-
0B(L)C & 0C	De-energized	-	-	-	-	4	-
	Energized	4	4	2	2	-	-
2A(L)	Both	6	6	5	5	-	-
2B(L) & 2C	Energized	5	5	2	2	-	-
6B(L) & 6C	De-energized	-	-	3	3	-	-
	Energized	6	6	1	1	-	-
8B(L) & 8C	All	7	7	5	5	3	-

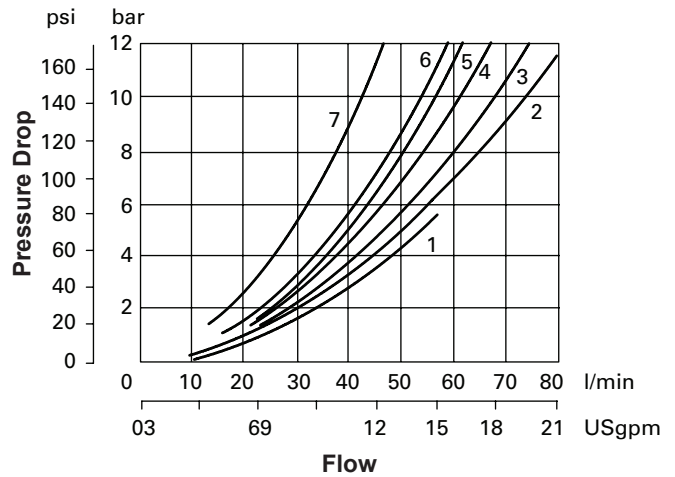

DG4V4-01, X5

Pressure drops in offset positions except where otherwise indicated.

Spool code	P to A	P to B	A to T	B to T	P to T
0	1	1	1	2	1
2	4	4	2	3	-
6	4	4	1	2	-
8	6	6	4	4	3

For other viscosities, pressure drops approximate to:

Viscosity cSt (SUS)						
14	20	43	54	65	76	85
(17.5)	(97.8)	(200)	(251)	(302)	(352)	(399)
% of Δp						
81	88	104	111	116	120	124

A change to another specific gravity will yield an approximately proportional change in pressure drop.

The specific gravity of a fluid may be obtained from its producer. Fire resistant fluids usually have higher specific gravities than oil.

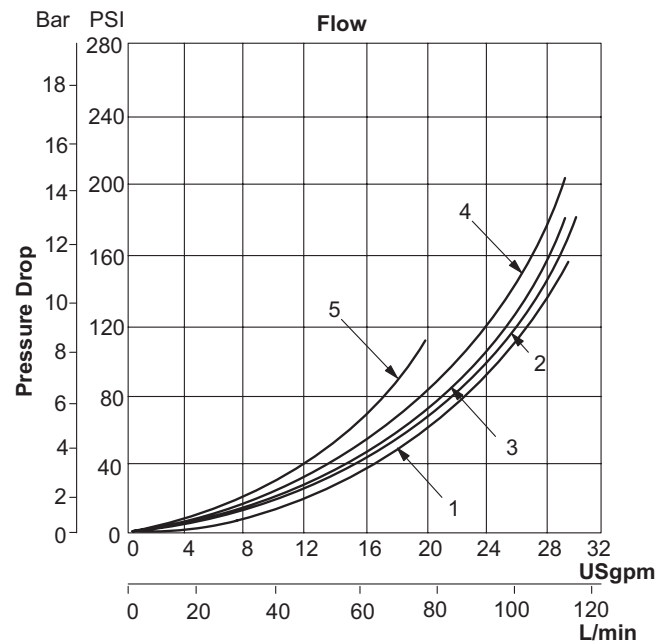

Installation Dimensions

In mm

DG4V-3S, X4

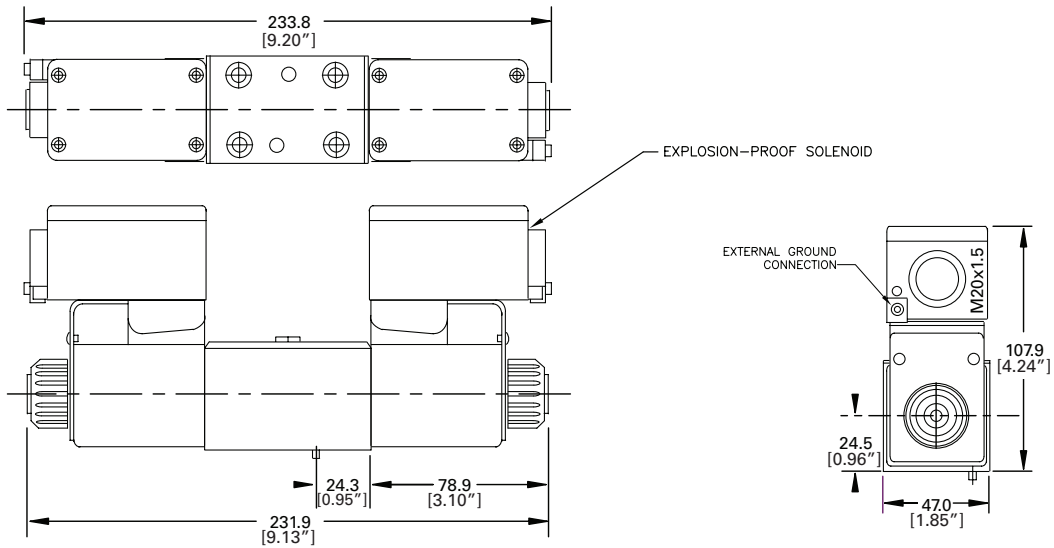

DG4V-3S, X5

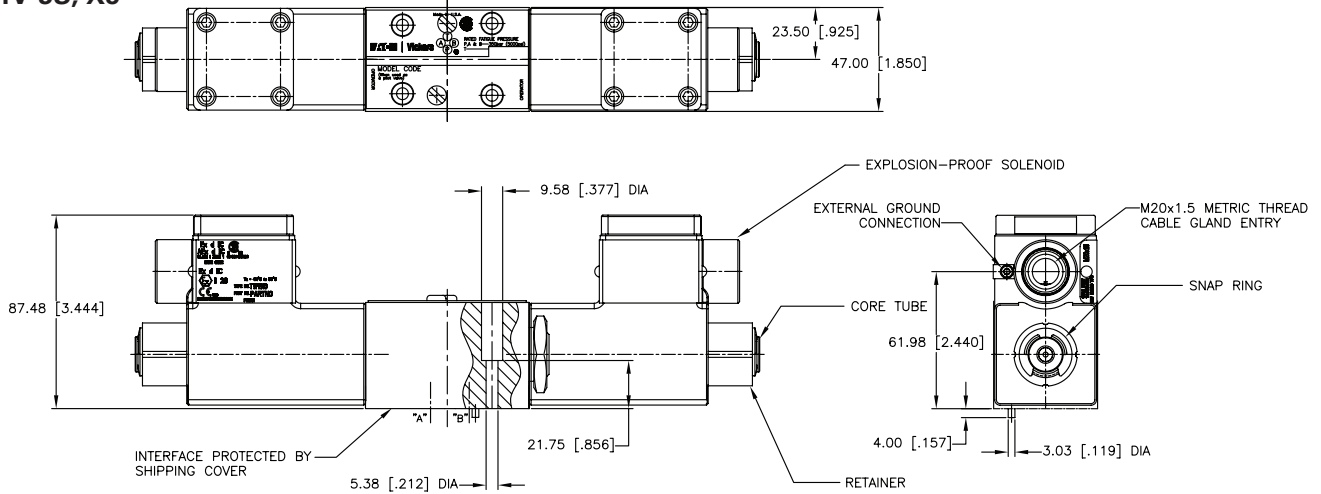

DG4V4-01, X5

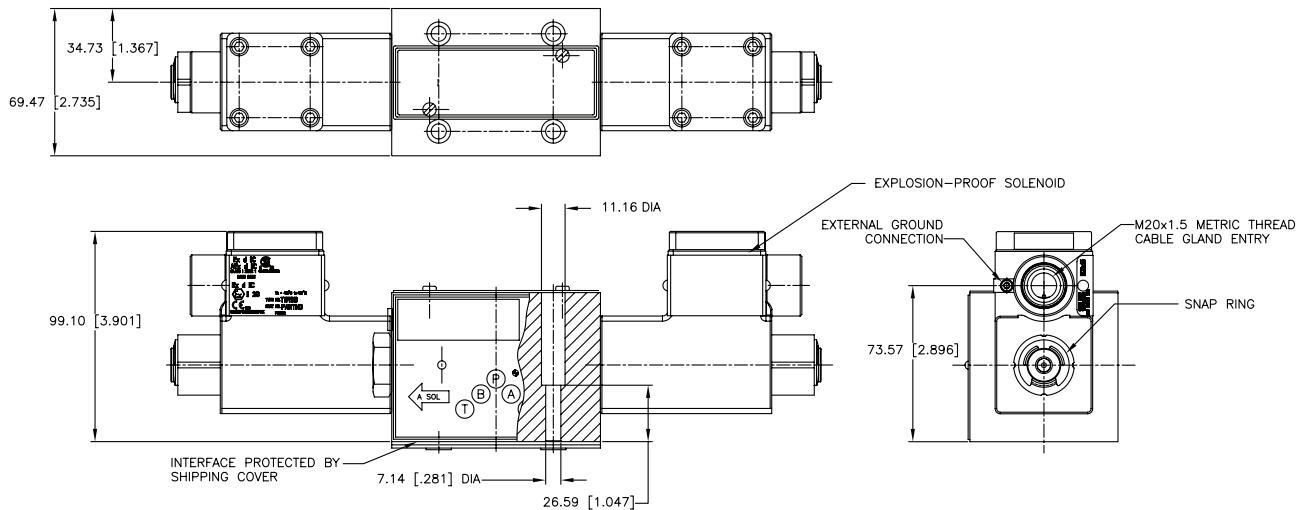

Application Data

Fluid Cleanliness

Proper fluid condition is essential for long and satisfactory life of hydraulic components and systems. Hydraulic fluid must have the correct balance of cleanliness, materials and additives for protection against wear of components, elevated viscosity and inclusion of air.

Recommendations on contamination control methods and the selection of products to control fluid condition are included in Eaton's publication 9132 or 561, "Vickers® Guide to Systemic Contamination Control". The book also includes information on the Eaton concept of "ProActive Maintenance". The following recommendations are based on ISO cleanliness levels at 2 µm, 5 µm and 15 µm.

For products in this catalog the recommended levels are:

0 to 70 bar (1000 psi):

18/16/13

70+ bar (1000+ psi):

17/15/12

Eaton products, as any components, will operate with apparent satisfaction in fluids with higher cleanliness codes than those described. Other manufacturers will often recommend levels above those specified.

Experience has shown, however, that life of any hydraulic component is shortened in fluids with higher cleanliness codes than those listed above. These codes have been proven to provide a long trouble-free service life for the products shown, regardless of the manufacturer.

Hydraulic Fluids

Materials and seals used in these valves are compatible with antiwear hydraulic oils, and non-alkyl-based phosphate esters. The extreme operating viscosity range is 500 to 13 cSt (2270 to 70 SUS) but the recommended running range is 54 to 13 cSt (245 to 70 SUS).

Installation

The valves in this catalog can be mounted in any attitude, but it may be necessary in certain demanding applications, to ensure that the solenoids are kept full of hydraulic fluid.

Mounting Bolt Kits

If not using Eaton recommended bolt kits, bolts used should be to ISO 898, 12.9 or better.

Mass, approx. kg (lb)

DG4V3S-*C = 3.5 kg
(7.72 lb)

DG4V3S-A/B = 2.3 kg
(5.07 lb)

DG4V4-01-*C = 6 kg
(13.2 lb)

DG4V4-01-*A/B = 4.5 kg
(10 lb)

Mounting Attitude

No restrictions.

Service Information

It is recommended that, should any mechanical or electronic repair be necessary, valves be returned to the nearest Eaton repair center.

The products will be refurbished as necessary and retested to specification before return.

This page left intentionally blank.

Eaton
Hydraulics Group USA
14615 Lone Oak Road
Eden Prairie, MN 55344
USA
Tel: 952-937-9800
Fax: 952-294-7722
www.eaton.com/hydraulics

Eaton
Hydraulics Group Europe
Route de la Longeraie 7
1110 Morges
Switzerland
Tel: +41 (0) 21 811 4600
Fax: +41 (0) 21 811 4601

Eaton
Hydraulics Group Asia Pacific
Eaton Building
4th Floor, No. 3 Lane 280 Linhong Rd.
Changning District
Shanghai 200335
China
Tel: (+86 21) 5200 0099
Fax: (+86 21) 5200 0400